

DADOS

Spectrograph

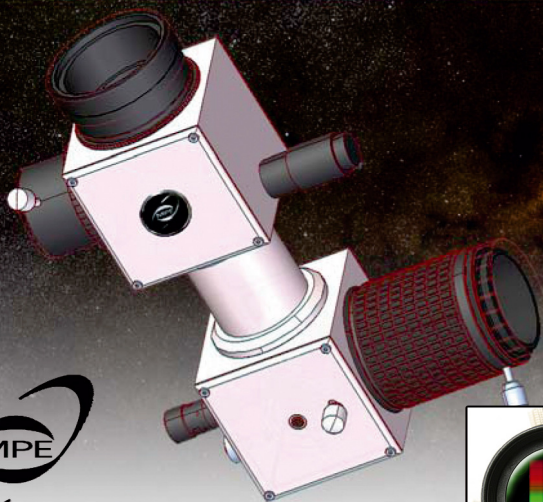

User's Manual

Jan 2014 – English Revision v1.4

The collaborators on the DADOS spectrograph project are:

- **Max-Planck Institut für Extraterrestrische Physik**
www.mpe.mpg.de
- **CAOS**
www.eso.org/projects/caos/
- **Baader Planetarium GmbH**
Zur Sternwarte
D - 82291 Mammendorf

Tel.: +49 (0) 8145 - 80 89-0
Fax: +49 (0) 8145 - 80 89-105

www.baader-planetarium.de

DADOS Spectrograph

User's Guide

Thank you for purchasing this Baader Planetarium product. To get the most out of your DADOS Spectrograph, please read this instruction manual thoroughly before starting to work with the spectrograph. Keep this User's Guide available for future reference and visit the Baader Planetarium website: <http://www.baader-planetarium.de> for up-to-date information about the product.



Unpacking

As you unpack the spectrograph, check the list below and make sure that all items shown above are included. If anything is missing contact your original retailer.

Standard accessories:

- DADOS spectrograph
- Eyepiece 20mm
- Eyepiece 10mm
- Slit Viewer Assy. (Guiding lens with M28.8-thread)
- T2 Quick Changer #2456313 (mounted at the DADOS)
- T2 Quick Change Ring #2456320 mounted at the eyepiece barrel with Focusing eyepiece holder (#2458125)
- Gloves for changing the grating
- Allen Wrench 1.5 mm
- Allen Wrench 1.3 mm
- 1 1/4" Stop ring 1905131
- Manual

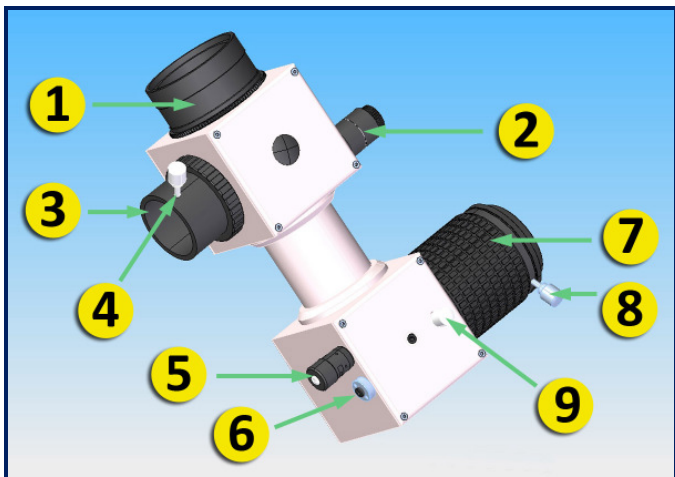

Part description

1. 2" Nosepiece
2. Slit illuminator
3. 1 1/4" Slit viewer port
4. Slit-viewer port locking screws
5. Micrometer
6. Rotation stage counter spring
(pre-adjusted, do not touch)
7. Focuser
8. Focuser locking screw
9. Grating angle locking screw

For a full list of accessories see Appendix D

Table of Contents

1. INTRODUCTION	8
2. QUICK SETUP	10
2.1 Attaching an eyepiece to the focuser	10
2.2 Focusing the spectrum	11
2.3 Changing the spectral range	13
2.4 Observing some common light sources	14
3. CONFIGURING DADOS FOR ASTRONOMICAL OBSERVATION	18
3.1 Coupling a detector to DADOS	19
3.1.1 Astronomical CCD camera	19
3.1.2 SLR or D-SLR body	22
3.2 Fine focusing of the camera objective	24
3.3 Selecting wavelength range	25
3.4 Using the slit-viewer	26
3.4.1 Attaching an eyepiece to the slit-viewer	26
3.4.2 Attaching a webcam to the slit-viewer	28
3.4.3 Zooming the slit view in and out	31
3.5 Coupling the spectrograph to the telescope	33
3.6 Operating the spectrograph at the telescope	34
APPENDIX A: MAINTENANCE	36
A.1 Battery replacement	36
A.2 Grating replacement	37

APPENDIX B: CARE OF THE OPTICAL COMPONENTS	43
APPENDIX C: SPECIFICATIONS	44
APPENDIX D: OPTIONAL ACCESSORIES	46
APPENDIX E: BIBLIOGRAPHY	47

1. Introduction

The DADOS spectrograph is an instrument that displays the spectra from different light sources. The name DADOS means “dice” in Spanish. It was designed to be used as either a spectroscope or as spectrograph, mainly for astronomical and instructional purposes. The device is very easy to use, robust, and versatile.

Please read this entire manual carefully to achieve the maximum use from this device.

The DADOS' main features are:

- Optimized for telescopes up to 14” aperture at f/10.
- Choice of 3 slits: 25, 35 and 50 μm .
- A red LED provides background illumination of the slits for easier focusing of a self-guiding camera.
- Default grating of 200 l/mm for low resolution, optional 900 l/mm grating for higher resolution.
- Micrometer for fine positioning of the central wavelength.
- The objective camera port has a built-in wide focusing range and uses the standard T2 adapter thread (M42 x 0.75).
- Accepts most CCD and DSLR cameras (with optional adapters). The camera interface is a T2 adapter with a standard M42 x 0.75 thread.
- The wide 55mm focusing range is suitable for attaching a DSLR-camera.



WARNING



**Never aim DADOS straight to the Sun!
Irreversible eye damage will occur!**

2. Quick setup

2.1 Attaching an eyepiece to the focuser

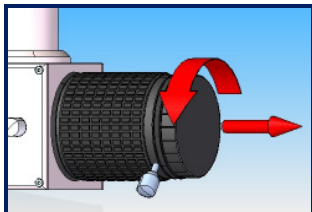

Remove the T2 dust cap by rotating it counterclockwise.

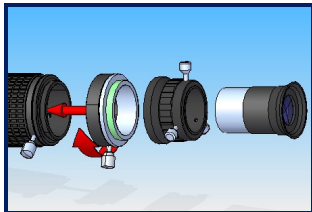

Mount the Baader T2 quick changing system (#2456313 + #2456320).

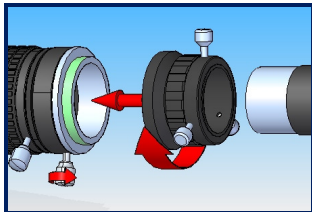

Lock the Baader T2 quick changing system and mount the focusing Baader eyepiece holder (#2458125).

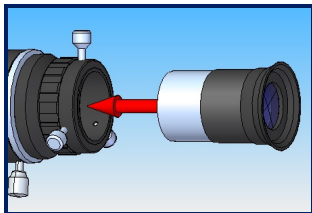

Insert the DADOS 20mm eyepiece (or the DADOS 10mm eyepiece for higher magnification) into the focusing eyepiece holder.

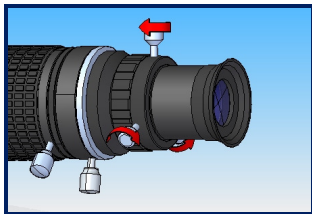

Lock the eyepiece with any of the three locking screws.

2.2 Focusing the spectrum

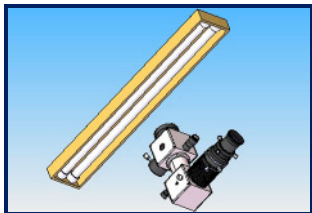

Point the 2" nosepiece (#1 on the page 5 diagram) to a fluorescent light source or a neon lamp.



Do not point directly to the Sun

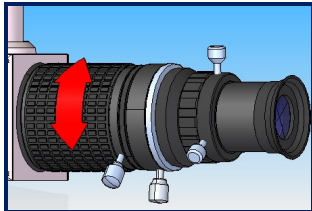

Rotate the focuser (#7) in order to focus the spectrum.

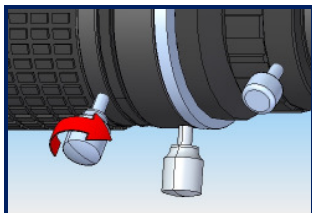

Lock the focus with the locking screw once sharp focus is achieved.

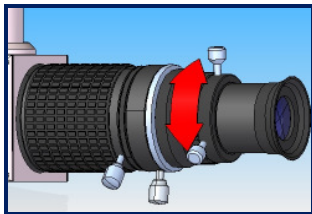

Rotate the focusing eyepiece holder for fine focus adjustments.

2.3 Changing the spectral range

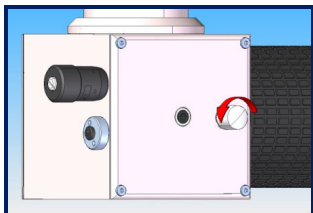

Slightly loosen the grating angle locking screw (#9).

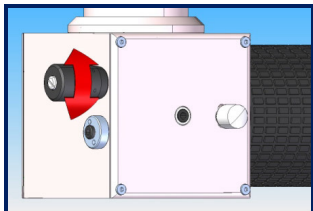

Center the spectral lines of your choice by adjusting the micrometer.

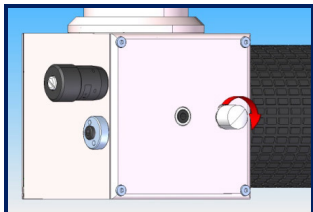

Tighten the grating angle locking screw (#9) to secure the selected setting.

2.4 Observing some common light sources

DADOS lets you observe and analyze a large variety of light sources. Specifically, you can quickly set up the instrument to observe:

- **Neon lamps**
(some pilot lights in washing machines, multi-outlet power strips, etc.)
- **Fluorescent lamps**
- **Continuous spectral sources**
(like tungsten or halogen lights)
- **Bright daylight**
Aim at the clear blue sky well away from the sun



**Never point directly
towards the Sun.**

Examples of spectra taken with DADOS and a 200 lines/mm grating:

HeAr calibration lamp

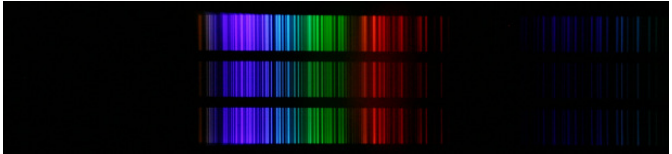

Neon

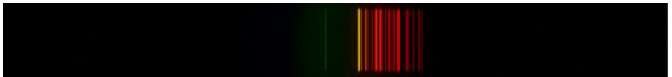

Continuous 1st and 2nd order



Solar spectrum



Note:

Spectra obtained with Canon 10D EOS Camera at different grating angles.

The calibration Lamp is only visible in the dark. Shield it from daylight or connect it to DADOS.

Examples of spectra taken with DADOS and a 900 lines/mm grating:

HeAr calibration lamp

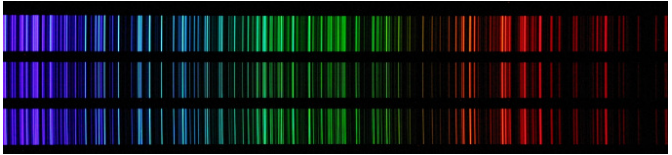

Neon

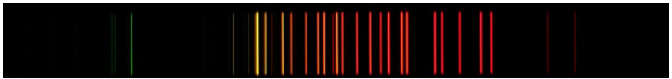

Fluorescent



Continuous



Solar spectrum

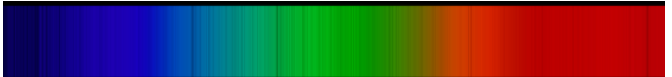

Note:

Spectra obtained with Canon 10D EOS Camera at different grating angles.

The Calibration Lamp is only visible in the dark. Shield it from daylight or connect it to DADOS.

3. Configuring DADOS for astronomical observation

The spectrograph should be set up correctly to ensure proper function.

3.1 Coupling a detector to DADOS

3.1.1 Astronomical CCD camera

The DADOS optical design is optimized to cover the field of CCD-chips with a dimension of 13,8x9,2mm and a pixel size of 9 μ m.

Detectors having larger chip size than 13.8 x 9.2 mm may be used; however, the optical image quality, and therefore the resolution, will slightly decrease at the edges.



Prepare the detector to be used in the observation, preferably:

SBIG ST-402ME, STF-8300, FLi ML 1603

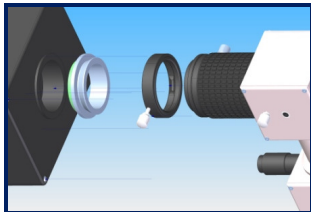

Use the Baader T2 quick changer system as the ideal device for coupling and rotating the camera without loss of focus.

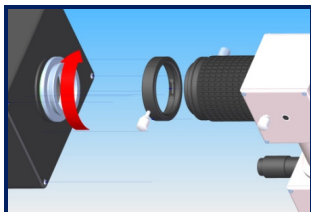

Mount the T2 change ring onto the SBIG detector.

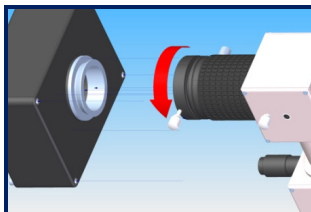

Mount the quick changer onto the T2 male thread of the DADOS collimator focuser (#7).

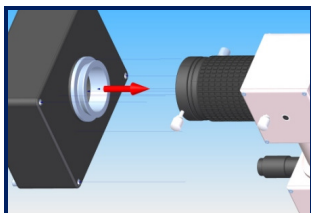

Join the detector and the change ring combo.

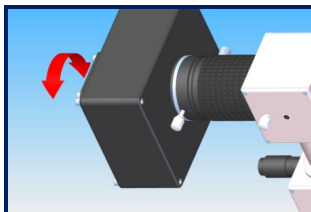

Rotate the camera into the desired orientation.

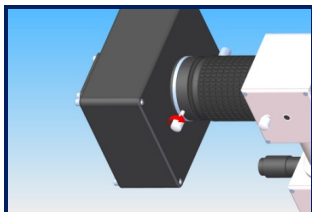

Clamp the camera by tightening the locking screw of the T2 quick changer.

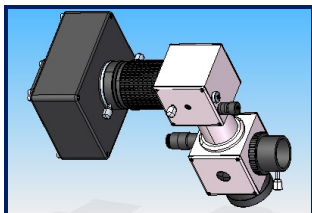

DADOS with imaging detector mounted.

3.1.2 SLR or D-SLR body

Obtain the appropriate T-Adapter for your type of camera.

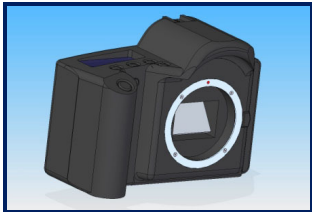

Prepare the DSLR camera body to be attached to the spectrograph.

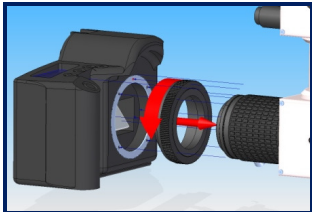

Screw the DSLR T-Ring onto the spectrograph focusing unit.

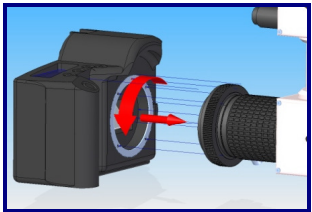

Attach the camera to the T-Ring adapter.

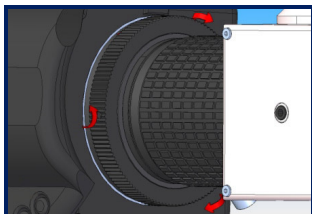

Open the three set screws of the Camera T-Ring.

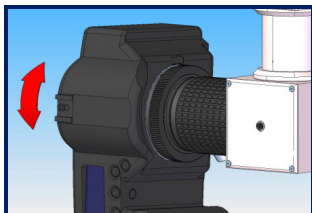

Rotate the camera body into the desired position.

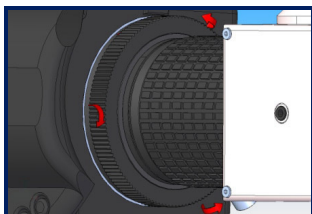

Lock the three set screws of the camera T-Ring.

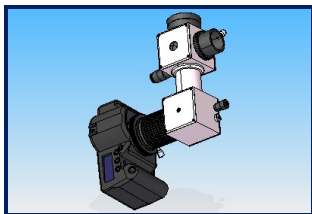

DADOS with mounted DSLR camera.

3.2 Fine focusing of the camera objective

Whether you have an astronomical CCD camera or a SLR body, follow the instructions below to achieve the best possible focus of the instrument.

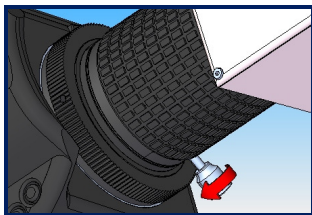

Loosen the focuser locking screw (#8) to focus the detector.

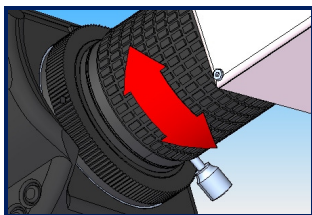

Rotate the focuser (#7) in order to focus the spectrum.

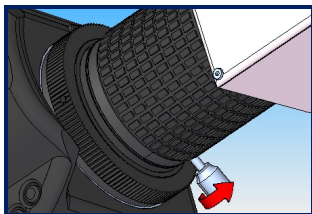

Lock the focus with locking screw (#8) when sharp focus is seen or recorded.

3.3 Selecting wavelength range

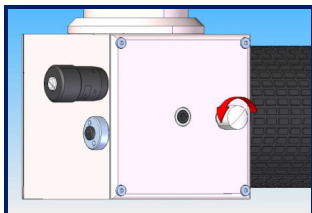

Slightly loosen the grating angle locking screw (#9).

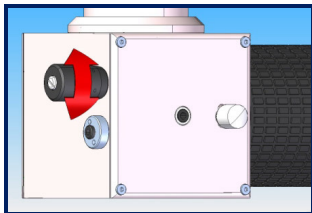

Center on certain spectral lines by rotating the micrometer (#5).



Prepare spectral charts of laboratory lamps*

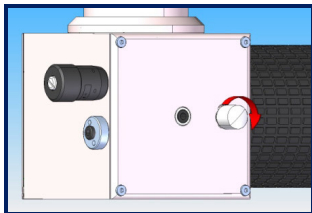

Tighten the grating angle locking screw to secure the selected setting.

- * If you want to download the spectral charts of some laboratory lamps go, for example, to <http://www.eso.org/projects/caos/>

3.4 Using the slit-viewer

3.4.1 Attaching an eyepiece to the slit-viewer

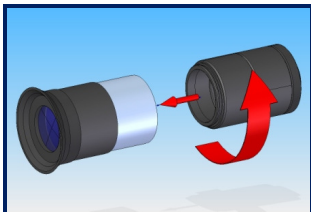

Mount the slit-viewer onto the 20mm DADOS guiding eyepiece.

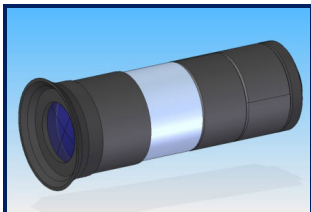

Slit-viewer attached to eyepiece.

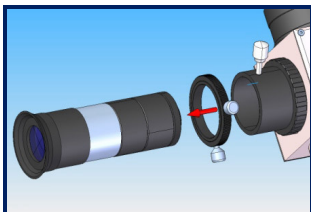

Slide the 1 1/4" stop ring onto the eyepiece's chrome sleeve and lock it.

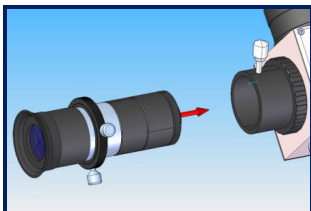

Insert the eyepiece assembly into the 1 1/4" slit viewing port (#3).

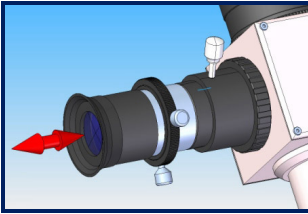

Focus the slit by manually pushing or pulling the eyepiece.

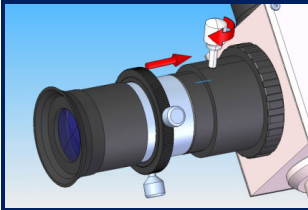

After having focused the image of the three slits, lock the eyepiece by using the locking screw (#4) of the 1 1/4" slit viewing port (#3).

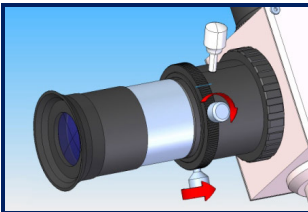

Open the set screws of the stop ring and move it ring down to sit flush on top of the eyepiece holder. Tighten the stop ring to secure proper focus position.

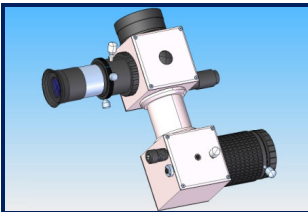

DADOS with mounted slit-viewer assembly.

3.4.2 Attaching a webcam to the slit-viewer

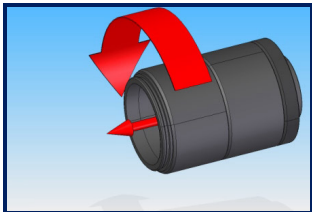

Remove the 18mm long 1 ¼" extension tube of the slit-viewer assy.

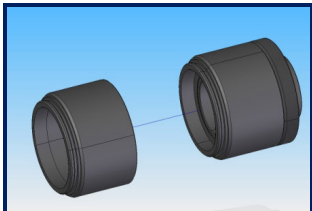

Mount the remaining body of the slit-viewer onto the 1 ¼" nosepiece of the webcam.
Example: Celestron NexImage 5 with the 1 ¼" nosepiece

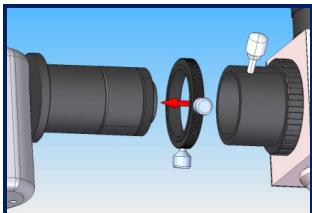
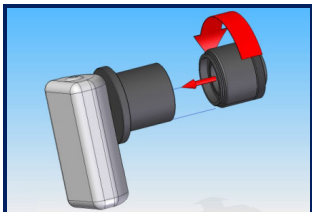

Slide the 1 ¼" stop ring onto the webcam nosepiece.

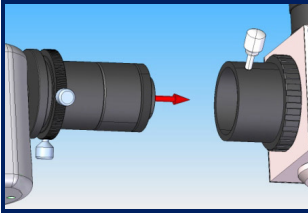

Attach the webcam combo to the 1 ¼" slit viewing port (#3).

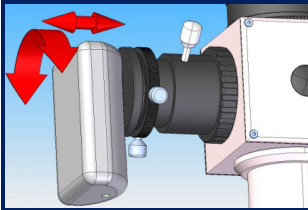

Focus the Webcam by manually pushing or pulling it. Rotate the Webcam body until it is approximately aligned with the major axis of DADOS.

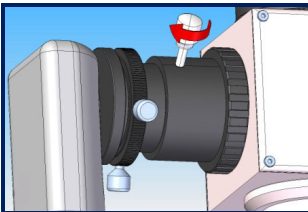

After having focused the image of the three slits, lock the webcam combo by using the locking screws (#4) of the 1 ¼" slit viewing port (#3).

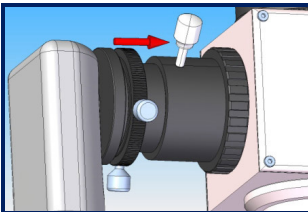

Open the set screws of the stop ring and move it to sit flush on top of the eyepiece holder / slit viewing port.

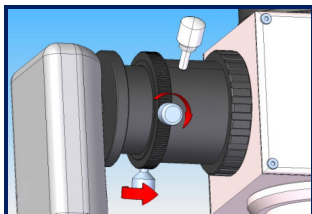

Tighten the Stop Ring to secure the proper focus position. Realign the orientation of the slit by rotating the Webcam.

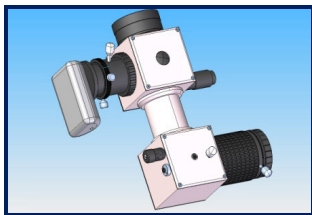

DADOS with Webcam mounted on to the slit viewer port.

3.4.3 Zooming the slit view in and out

The lens inside the slit viewer can be adjusted in order to magnify the image size of the 3 slits on the detector of the Webcam.

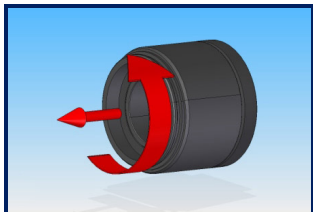

Remove the second 1 ¼” extension tube from the slit viewer body.

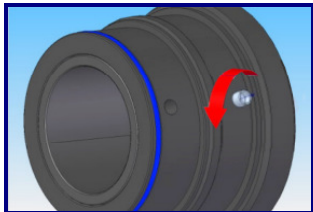

Loosen the headless set screw inside the slit viewer body by only ½ turn, using the supplied Allen wrench (1.3mm).

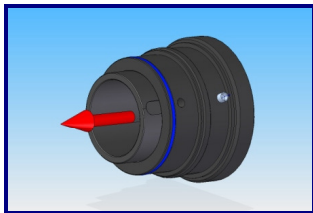

Slide the lens holder tube towards the Webcam to reduce image size.

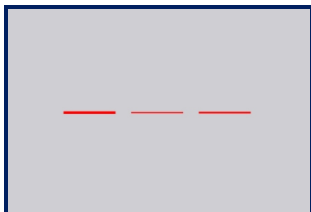

Minimum magnification as seen by the CCD chip.

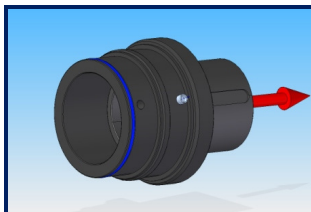

Slide the lens holder tube away from the Webcam in order to magnify the image.

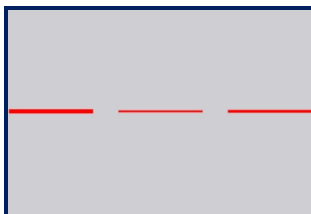

Maximum magnification as seen by the CCD chip.

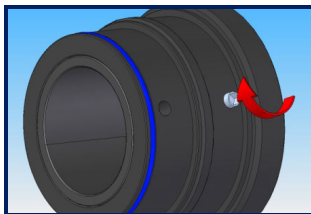

Lock the new position of the lens holder tube by tightening the headless set screw.

Remount the slit-viewer body onto the webcam with one 18mm extension tube.

3.5 Coupling the spectrograph to the telescope

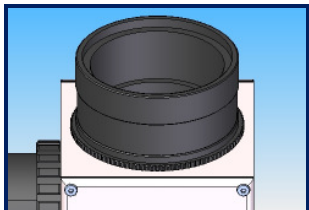

Use the provided 2" nosepiece to attach DADOS to your telescope.

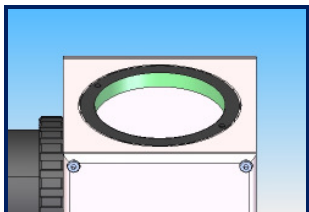

Alternatively use the female T-2 thread (M42 x 0.75), by removing the 2" nosepiece.

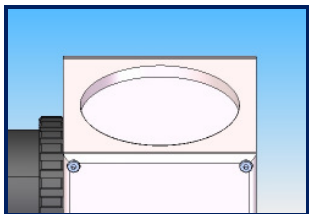

Or remove the female T-2 thread adapter to get access to a female 2" thread in DADOS body.

3.6 Operating the spectrograph at the telescope

Before attaching DADOS to the telescope, make sure you have already focused the spectrum on the camera's focal plane, with the proper orientation.

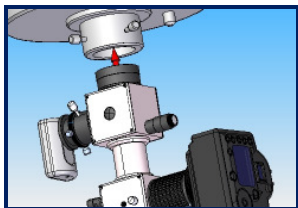

Attach DADOS onto the Telescope with a 2" interface if using the 2" nosepiece.

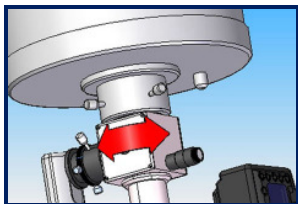

Align the instrument to the telescope. For equatorial mounts, the best orientation is with the slit parallel to the right ascension axis.

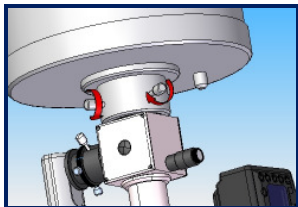

Ensure the attachment of the instrument to the telescope by locking the proper adapter screws. Then slew the telescope to a bright star.

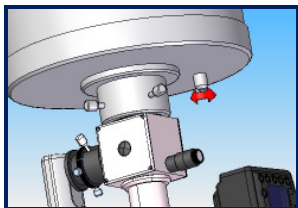

Use the telescope's focusing mechanism to focus the star in the middle of the slit by observing its image through an eyepiece or webcam.

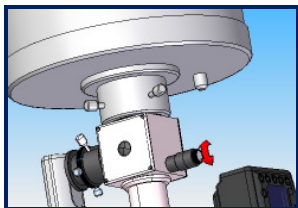

Use the slit illuminator (#2) to illuminate the slits and slowly slew the telescope to bring the star inside one of the slits. Switch off the slit illuminator before starting an exposure with the detector.

Appendix A: Maintenance

A.1 Battery replacement

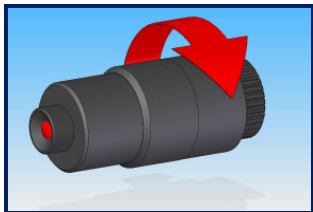

Simply turn the back of the Illuminator counterclockwise approximately three turns to open the battery compartment.

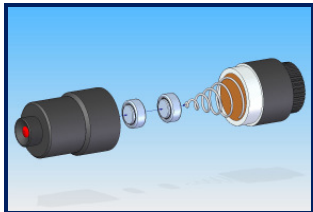

Replace dead batteries with two round “hearing aid” batteries 1.5V (such as Camilion AG 3 SR 41 #2454306).

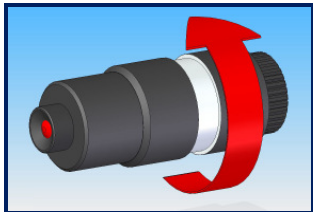

Then turn the back of the illuminator clockwise till it is completely closed.

A.2 Grating replacement



Touching the grating will destroy it beyond repair!

Do not attempt to remove dust by breathing or blowing air onto the grating! Small droplets of moisture and saliva can permanently damage the grating as well.

Do not use compressed or canned air! This will likewise transport moisture, grease or propellant onto the grating.

Any exchange of grating holders should always be performed in clean surroundings, free of dust and static build up.

Arrange your workplace for ensure a quick and clean grating exchange.



Have the 900 lines/mm grating with holder readily available.

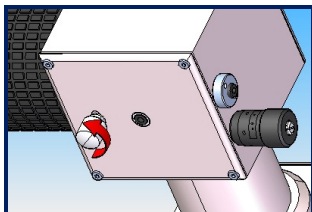

Loosen the grating angle locking screw (#9) by one turn only.

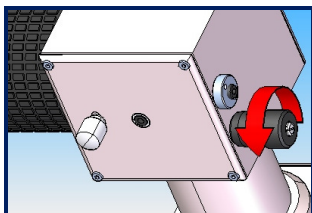

Rotate the micrometer backwards to show an 8mm setting on the Vernier scale.

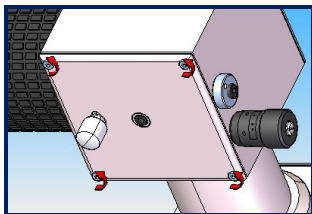

Use the 1.5mm Allen wrench to remove the four hex-head screws.

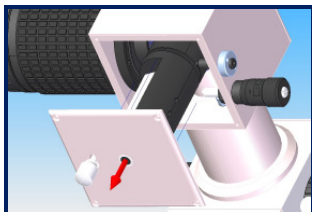

Take off the side plate/grating holder assembly.



Be careful not to touch the grating.

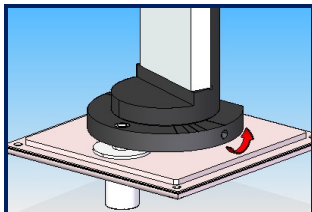

Release the headless set screw inside of the pressure plate by 2 full turns counterclockwise using the 1.5mm Allen wrench.

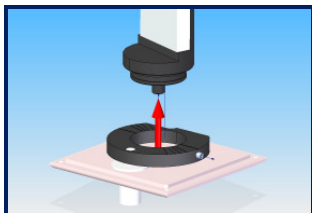

Remove the grating holder from the pressure plate.



Take the 900 lines/mm grating holder out of the storage container and store the 200 lines/mm grating in it.



Place the 900 lines/mm grating holder into the pressure plate.

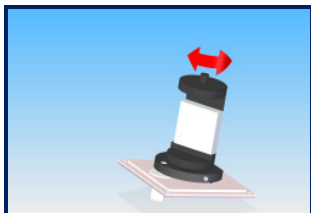

Rotate the grating holder to adjust the proper position in regard to the markings in the pressure plate.

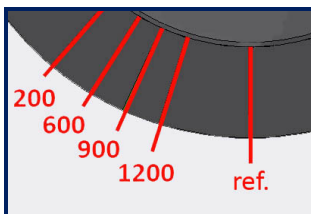

Each mark indicates the position of a specific grating. Be sure to use the proper one to achieve the optimal throughput.

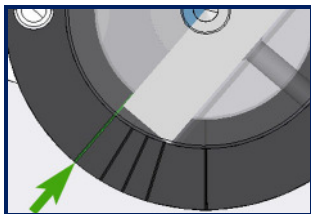

Example of position:
200 lines/mm grating.

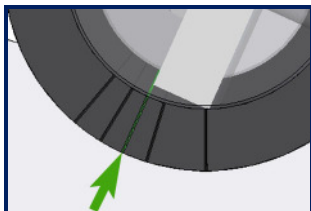

Example of position:
900 lines/mm grating.

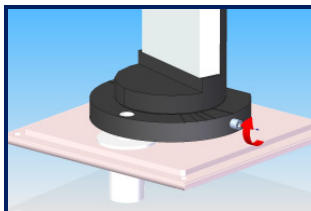

Lock the pressure plate by
tightening the headless set
screw clockwise.

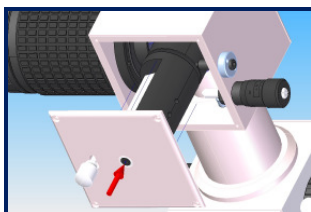

Carefully replace the side
plate/grating holder
assembly.

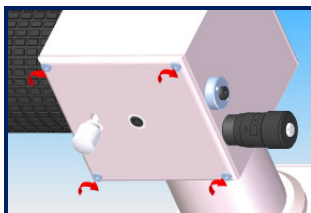

Replace and tighten the 4
screws that secure the side
plate.

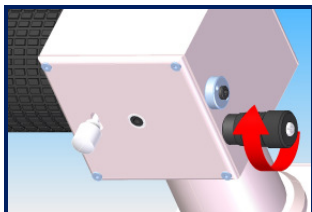

Adjust the micrometer to a Vernier position of approximately 2.5.

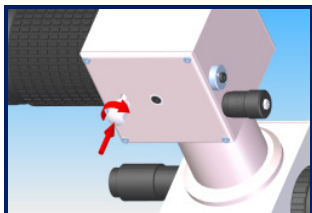

Lock the grating tilt mechanism by rotating the grating angle locking screw clockwise.

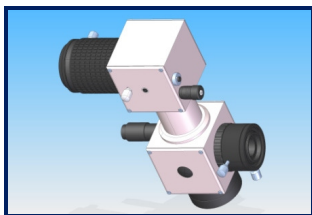

DADOS with grating exchanged.

Appendix B: Care of the Optical components

If you always use dust caps after working with the DADOS, no cleaning will be necessary.

Dust can only be cleaned from the grating and slit by Baader-Planetarium. Do not clean gratings or slit yourself as this may void the warranty.

Lenses cannot be cleaned with common cleaning agents.

Use only Baader Planetarium Optical Wonder fluid (#2905007) to clean the lenses.

Appendix C: Specifications

Mechanical

Weight (without cameras and eyepieces)	0.85 kg
Dimensions (see Figure in Part Description)	80 × 150 × 205 mm

Electrical

Red LED Battery	SR 41 or equivalent
-----------------	---------------------

Environmental

Operating temperature	-10 to +30°C
Storage temperature	-30 to +35°C
Humidity (relative)	0 to 80 %
Storage humidity	0 to 60 %

Optical

Collimator focal ratio	f/10 *
Collimator focal length	80 mm
Objective focal length	96 mm
Collimator – Camera angle	90°
Dispersion on axis at 550 nm	
- 200 lines/mm grating	39.7 nm/mm
- 900 lines/mm grating (optional)	10.6 nm/mm

* Using the DADOS with a telescope of lower focal ratio than f/10 degrades the resolving power and increases the vignetting

Performances

Resolving power $\lambda / \Delta \lambda$ on camera objective axis and 25 μm slit

Grating of 200 lines/mm		
Theoretical	Measured	λ (nm)
396	542	@ 416
606	647	@ 616
668	723	@ 697

Grating of 900 lines/mm		
Theoretical	Measured	λ (nm)
2038	2000	@ 371
3910	3000	@ 561
5376	5000	@ 800

Limiting magnitude for a 30 cm \varnothing telescope with S/N 50 and 20 minutes of exposure time.

For the 200 lines/mm grating : $m_v = 8$

For the 900 lines/mm grating : $m_v = 6$

Note:

Measurements performed w. ST-8 XME w. 9 micron pixel size.

The measured resolving power of the 900L grating was limited by the pixel matching.

With smaller pixels a higher resolution can be measured.

Appendix D: Optional accessories

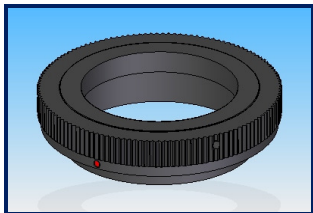

T2 adapters for many SLR camera models. Examples:

Nikon	Ref. 240 8300
Canon EF	Ref. 240 8319

See the Baader Planetarium Web site for a complete list.

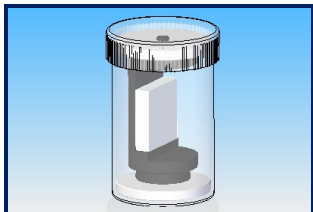

Reflection grating
25 x 25 x 9mm, 900 lines/mm
mounted in quick exchanger.

Ref. 245 8555

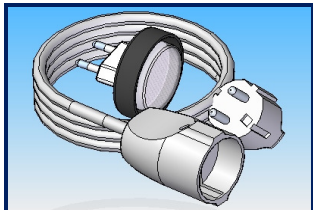

Calibration Neon lamp for
DADOS with 220V power
cord and 2" adapter.

Ref. 245 8590

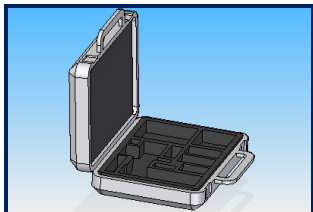

Travel case for DADOS with
flexible compartments for
tools.

Ref. 245 2110



Dados rings for mounting on
tripods or optical bench

B.-Nr. 245 8593



Appendix E: Bibliography

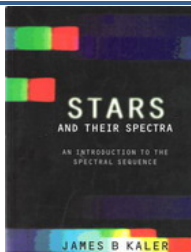

Stars and Their Spectra: An Introduction to Spectral Sequence

Author: James B. Kaler
Pub 1989
Pages: 300
ISBN: 0521304946

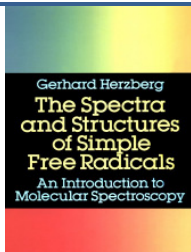

The Spectra and Structures of Simple Free Radicals: an introduction to Molecular Spectroscopy

Author: Gerhard Herzberg
Pub 1989
Pages: 300

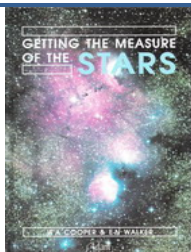

Getting the Measure of the Stars

Author: W.A. Cooper
Pub 1989
Pages: 293
ISBN: 0852748302

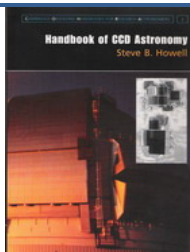

Handbook of CCD Astronomy

Author: Steve Bruce Howell
Pub 2006
Pages: 208
ISBN: 0521852153

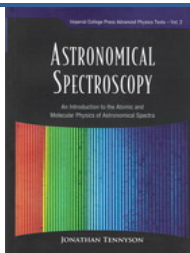

Astronomical Spectroscopy: an Introduction to the Atomic and Molecular Physics of Astronomical Spectra

Author: Jonathan Tennyson
Pub 2005
Pages: 192

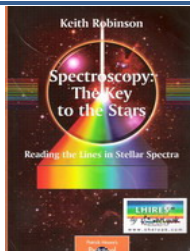

Spectroscopy: the Key to the Stars: Reading the Lines in Stellar Spectra

Author: Keith Robinson
Pub 2007
Pages: 160
ISBN: 9780387367866

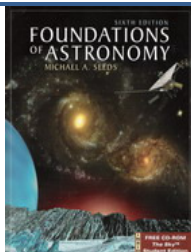

Foundations of Astronomy.

Author: Michael A. Seeds
Pub 2000
Pages: 656
ISBN: 0534378552

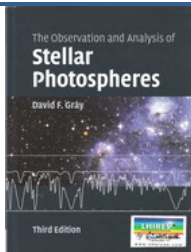

The Observation and Analysis of Stellar Photospheres

Author: David F. Gray
Pub 2005
Pages: 533
ISBN: 0521851866

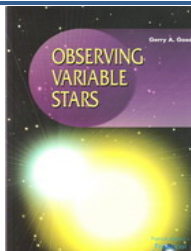

Observing Variable Stars

Author: Gerry A. Good
Pub 2003
Pages: 274
ISBN: 1852334983

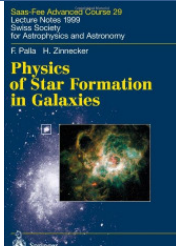

Physics of Star Formation in Galaxies

Author: Francesco Palla
Pub 2002
Pages: 232
ISBN: 3540431020

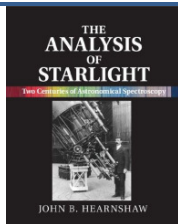

The Analysis of Starlight. One Hundred and Fifty Years of Astronomical Spectroscopy

Author: John B. Hearnshaw
Pub 2014
Pages: 448
ISBN: 978-1107031746

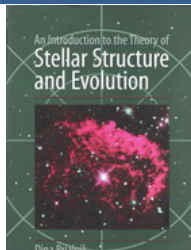

An Introduction to the Theory of Stellar Structure and Evolution

Author: Dina Prialnik
Pub 2000
Pages: 261
ISBN: 9780521659376

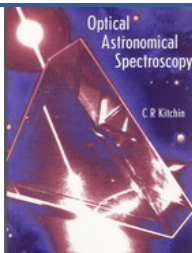

Optical Astronomical Spectroscopy

Author: Christopher R. Kitchin
Pub 1995
Pages: 272
ISBN: 0750303468

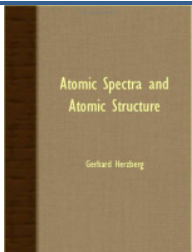

Atomic Spectra and Atomic Structure

Author: Gerhard Herzberg
Pub 2007
Pages: 527
ISBN: 140675322X

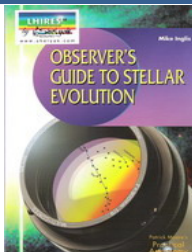

Observers Guide to Stellar Evolution

Author: Mike Inglis
Pub 2007
Pages: 236
ISBN: 1852334657



Spectrograph Design Fundamentals

Author: John James
Pub 2007
Pages: 204
ISBN: 10-0521864631

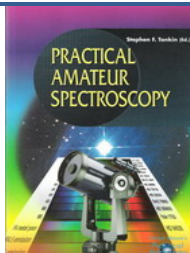

Practical Amateur Spectroscopy

Author: Stephen F. Tonkin et al.
Pub 2002
Pages: 210
ISBN: 1852334894

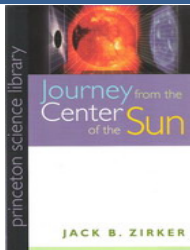

Journey from the Center of the Sun

Author: Jack B. Zirker
Pub 2002
Pages: 302
ISBN: 0691057818

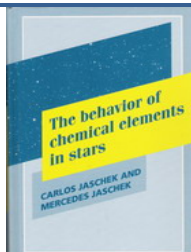

The Behavior of Chemical Elements in Stars

Author: Carlos Jaschek
Pub 1995
Pages: 324
ISBN: 052141136X



The Classification of Stars

Author: Carlos Jaschek
Pub 1990
Pages: 413
ISBN: 0521267730

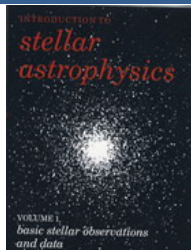

Introduction to Stellar Astrophysics. Vol.3: Stellar Structure and Evolution

Author: Erika Boehm-Vitense
Pub 1992
Pages: 285
ISBN: 0521348714

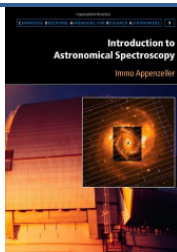

Introduction to Astronomical Spectroscopy

Author: Immo Appenzeller
Pub 2013
Pages: 268
ISBN: 978-1107601796

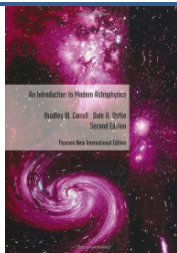

An Introduction to Modern Astrophysics

Author: Bradley W. Carroll, Dale A. Ostlie
Pub 2013
Pages: 1478
ISBN: 978-1292022932

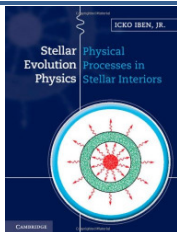

Stellar Evolution Physics: Physical Processes in Stellar Interiors

Author: Icko Iben, jr.
Pub 2012
Pages: 906
ISBN: 978-1107016569

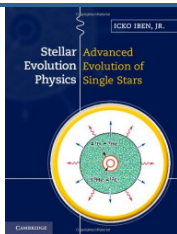

Stellar Evolution Physics: Advanced Evolution of Single Stars

Author: Icko Iben, jr.
Pub 2012
Pages: 616
ISBN: 978-1107016576

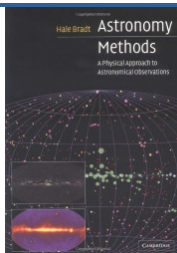

Astronomy: Methods

Author: Hale Bradt
Pub 2003
Pages: 458
ISBN: 978-0521535519

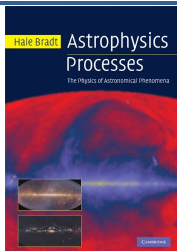

Astrophysics: Processes

Author: Hale Bradt
Pub 2008
Pages: 536
ISBN: 978-0521846561

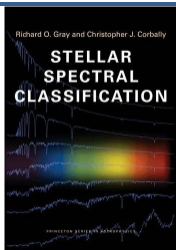

Stellar Spectral Classification

Author: Richard O. Gray,
Christopher J. Corbally

Pub 2009

Pages: 592

ISBN: 978-0691125114

WAVELENGTH SETTINGS

Camera
Model: _____

Grating: _____
—

Micrometer position	Central Wavelength

Camera
Model: _____

Grating: _____
—

Micrometer position	Central Wavelength

Camera
Model: _____

Grating: _____
—

Micrometer position	Central Wavelength

WAVELENGTH SETTINGS

Camera
Model: _____

Grating: _____
—

Micrometer position	Central Wavelength

Camera
Model: _____

Grating: _____
—

Micrometer position	Central Wavelength

Camera
Model: _____

Grating: _____
—

Micrometer position	Central Wavelength

Except for brief quotation in critical articles or reviews, no reproduction of this manual, in any form, in whole or in part, may be made without written authorization of Baader Planetarium GmbH.



Baader Planetarium GmbH

Zur Sternwarte

D - 82291 Mammendorf

Tel.: +49 (0) 8145 - 80 89-0

Fax: +49 (0) 8145 - 80 89-105

www.baader-planetarium.de